

Braat 1844 HI (dubbel glas)

DETAILBOEK

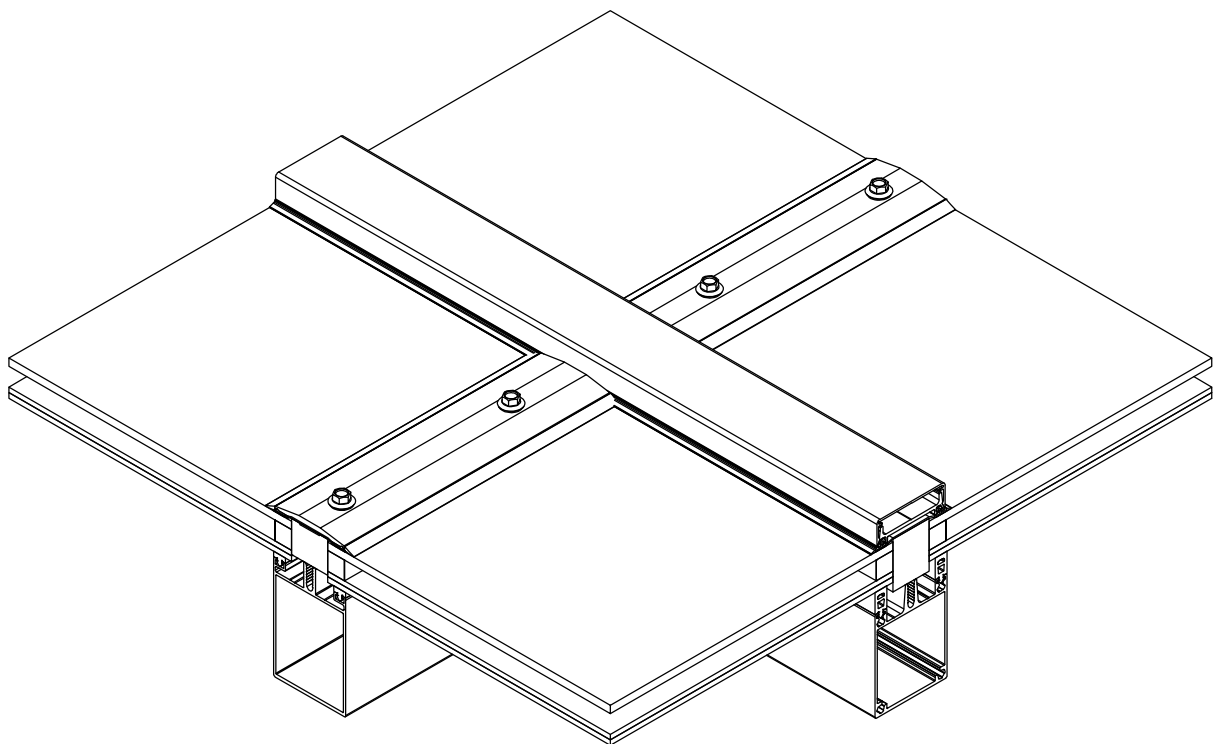

Braat glasconstructies 1844 BV
Postbus 6
2600 AA Delft
T: +31(0)15 2516767
F: +31(0)15 2571667
E: info@braatglasconstructies.nl
I: www.braatglasconstructies.nl

Braat 1844 HI (dubbel glas)

OVERZICHT

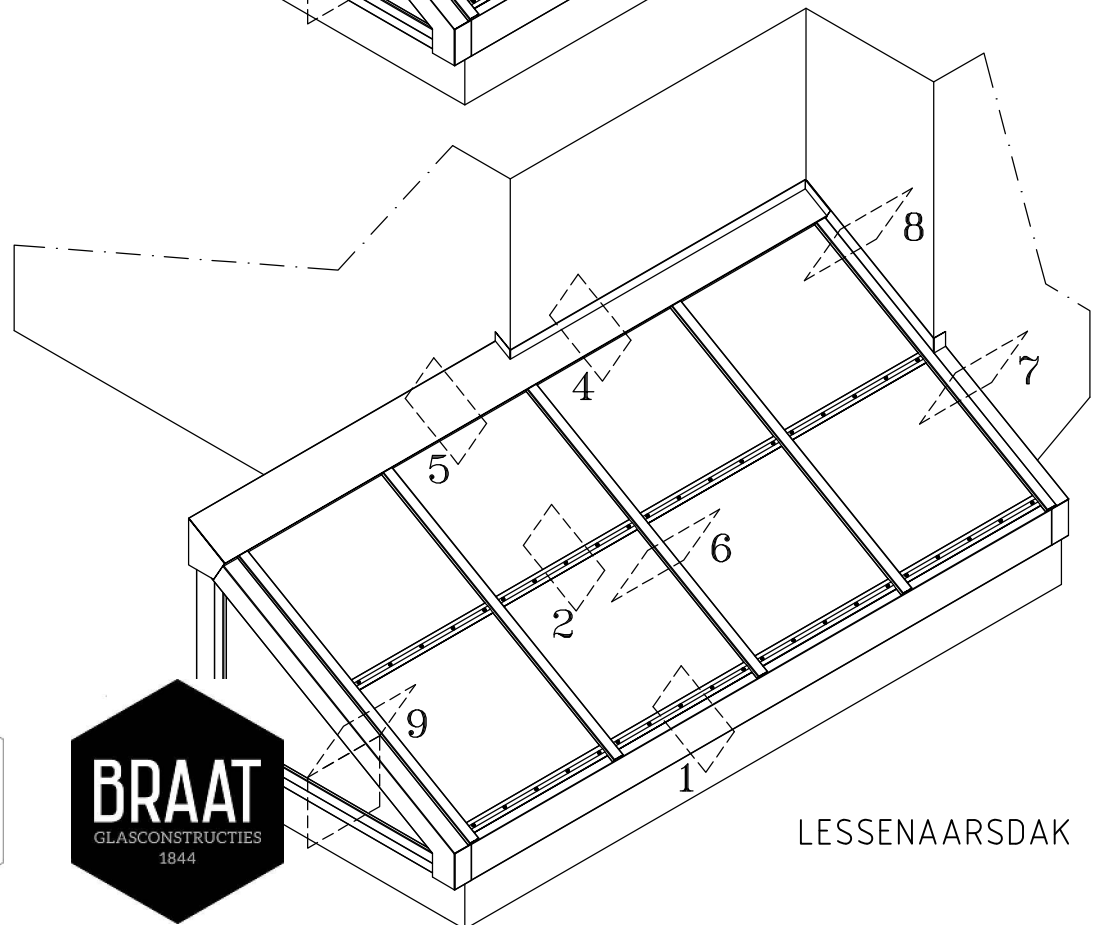
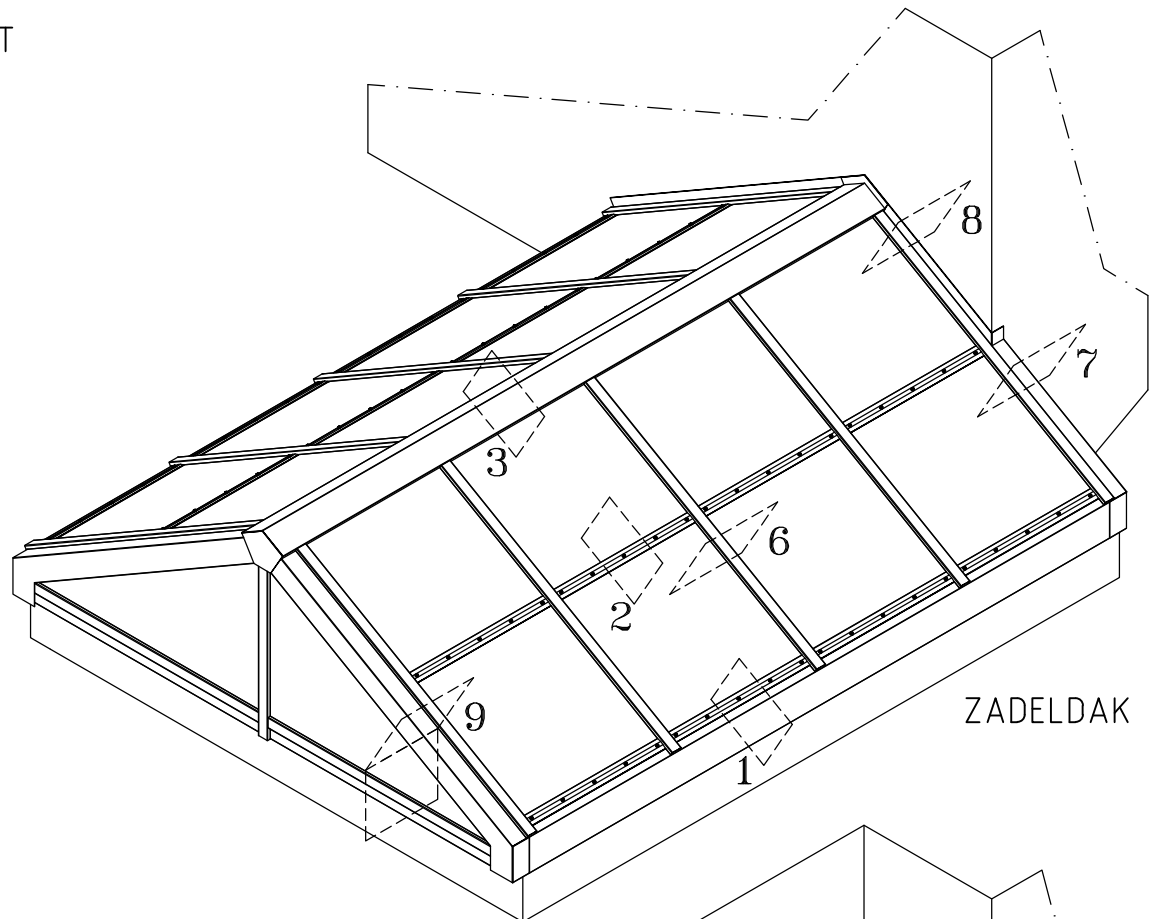

Braat glasconstructies 1844 BV
Postbus 6
2600 AA Delft
T: +31(0)15 2516767
F: +31(0)15 2571667
E: info@braatglasconstructies.nl
I: www.braatglasconstructies.nl

Braat 1844 HI (dubbel glas)

ONDERDETAIL
Schaal 1:2

DETAIL 1

SCHROEF V.V. NEOPREEN AFDICHRING

DEKLIJST

HARDHOUT (MERANTI)

PUR ISOLATIE

ALUM. PLAAT 2mm

AFVOER CONDENSATER

DELING

LUCHTDICHTING

WATERDICHTE FOLIE

COMPRI-BAND (ONDERBROKEN T.P.V. ROEDE)

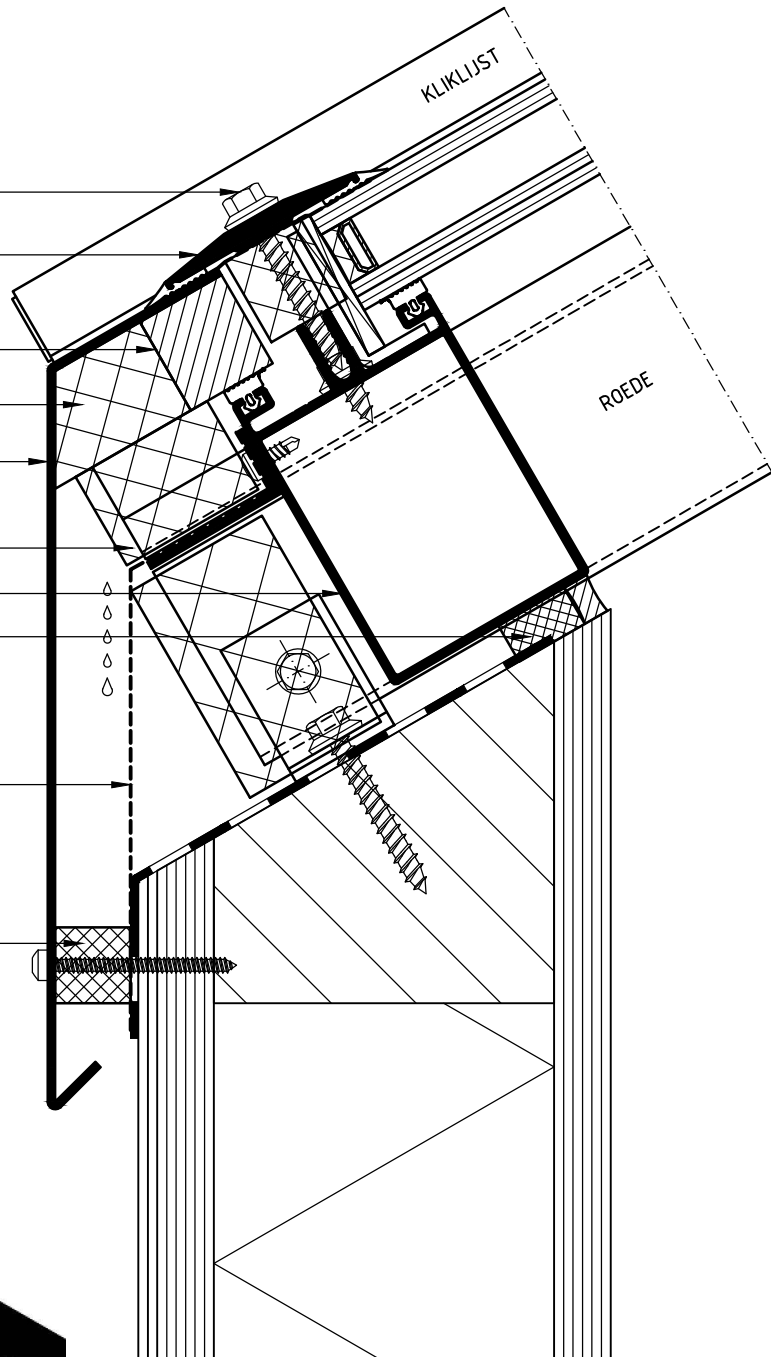

Braat glasconstructies 1844 BV
Postbus 6
2600 AA Delft
T: +31(0)15 2516767
F: +31(0)15 2571667
E: info@braatglasconstructies.nl
I: www.braatglasconstructies.nl

Braat 1844 HI (dubbel glas)

GLASDELING
Schaal 1:2

DETAIL 2

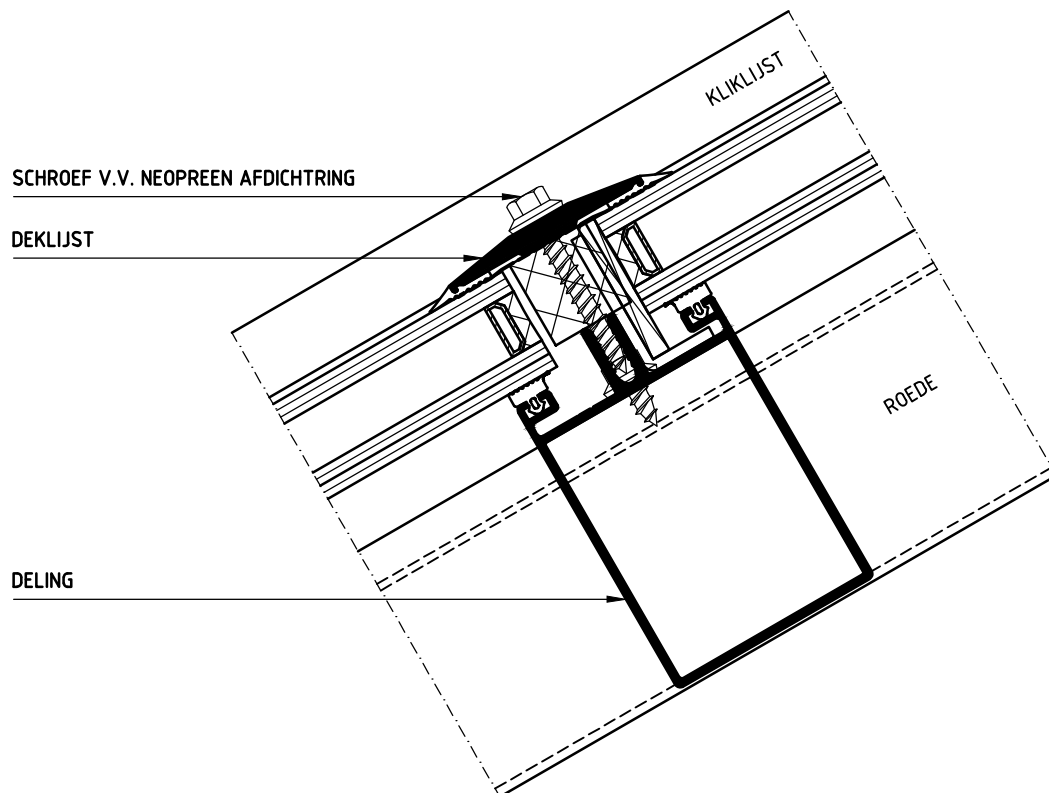

Braat glasconstructies 1844 BV
Postbus 6
2600 AA Delft
T: +31(0)15 2516767
F: +31(0)15 2571667
E: info@braatglasconstructies.nl
I: www.braatglasconstructies.nl

Braat 1844 HI (dubbel glas)

NOKDETAIL ZADELDAK
Schaal 1:2

DETAIL 3

ALUM. PLAAT 2mm

WATERDICHTE FOLIE

PUR ISOLATIE

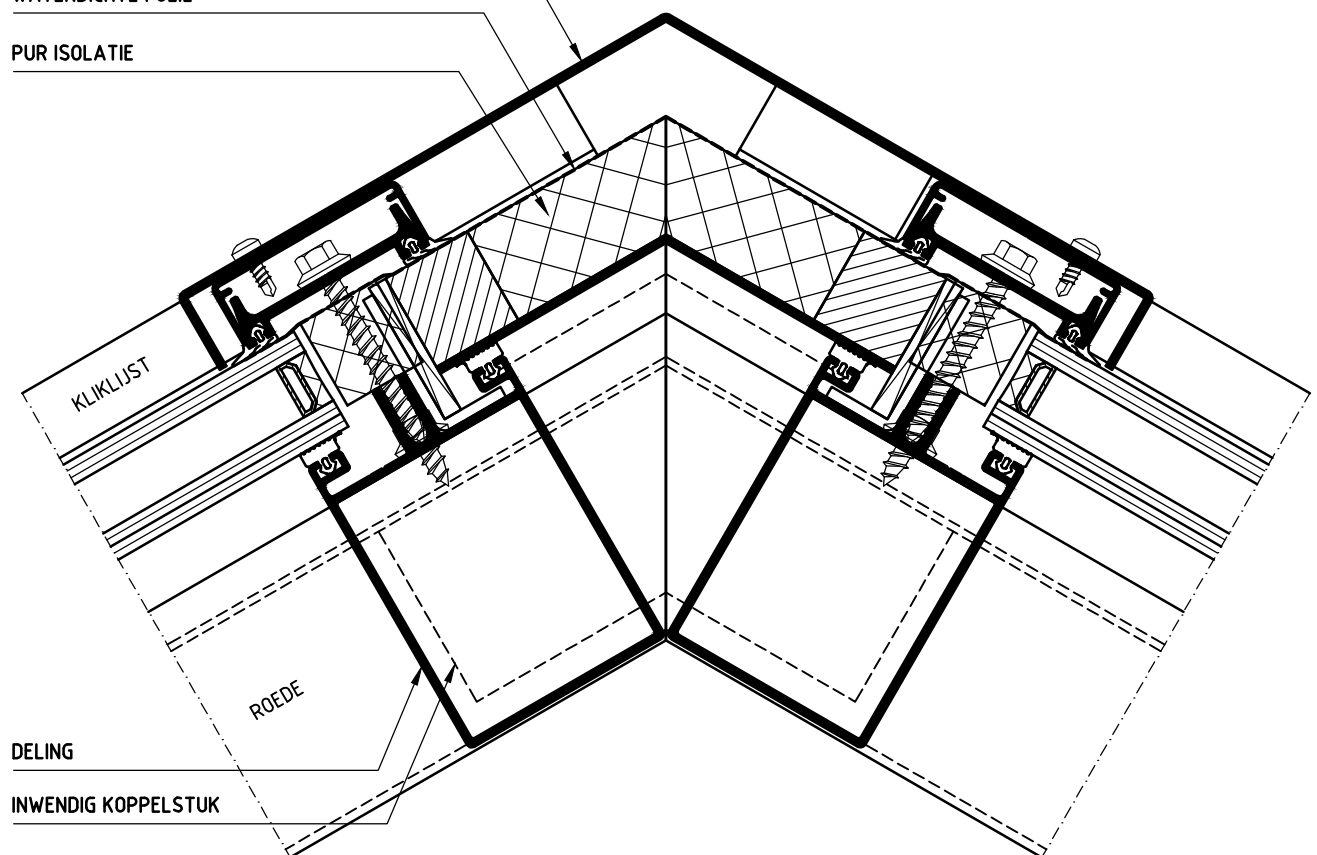

Braat glasconstructies 1844 BV
Postbus 6
2600 AA Delft
T: +31(0)15 2516767
F: +31(0)15 2571667
E: info@braatglasconstructies.nl
I: www.braatglasconstructies.nl

Braat 1844 HI (dubbel glas)

NOKDETAIL LESSENAARSDAK (OPGAAND WERK)
Schaal 1:2

DETAIL 4

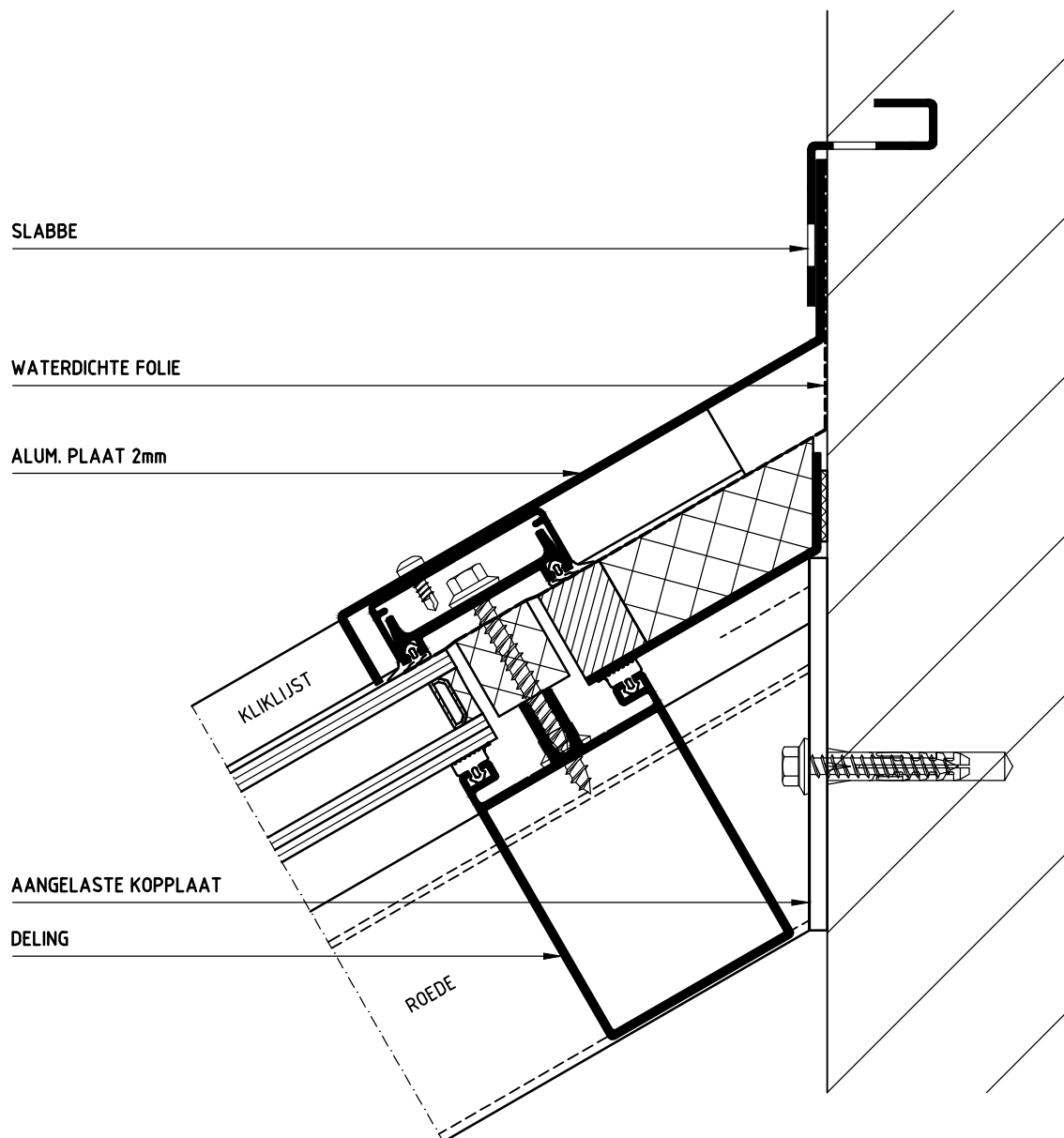

Braat glasconstructies 1844 BV
Postbus 6
2600 AA Delft
T: +31(0)15 2516767
F: +31(0)15 2571667
E: info@braatglasconstructies.nl
I: www.braatglasconstructies.nl

Braat 1844 HI (dubbel glas)

NOKDETAIL LESSENAARSDAK (OPSTAND)
Schaal 1:2

DETAIL 5

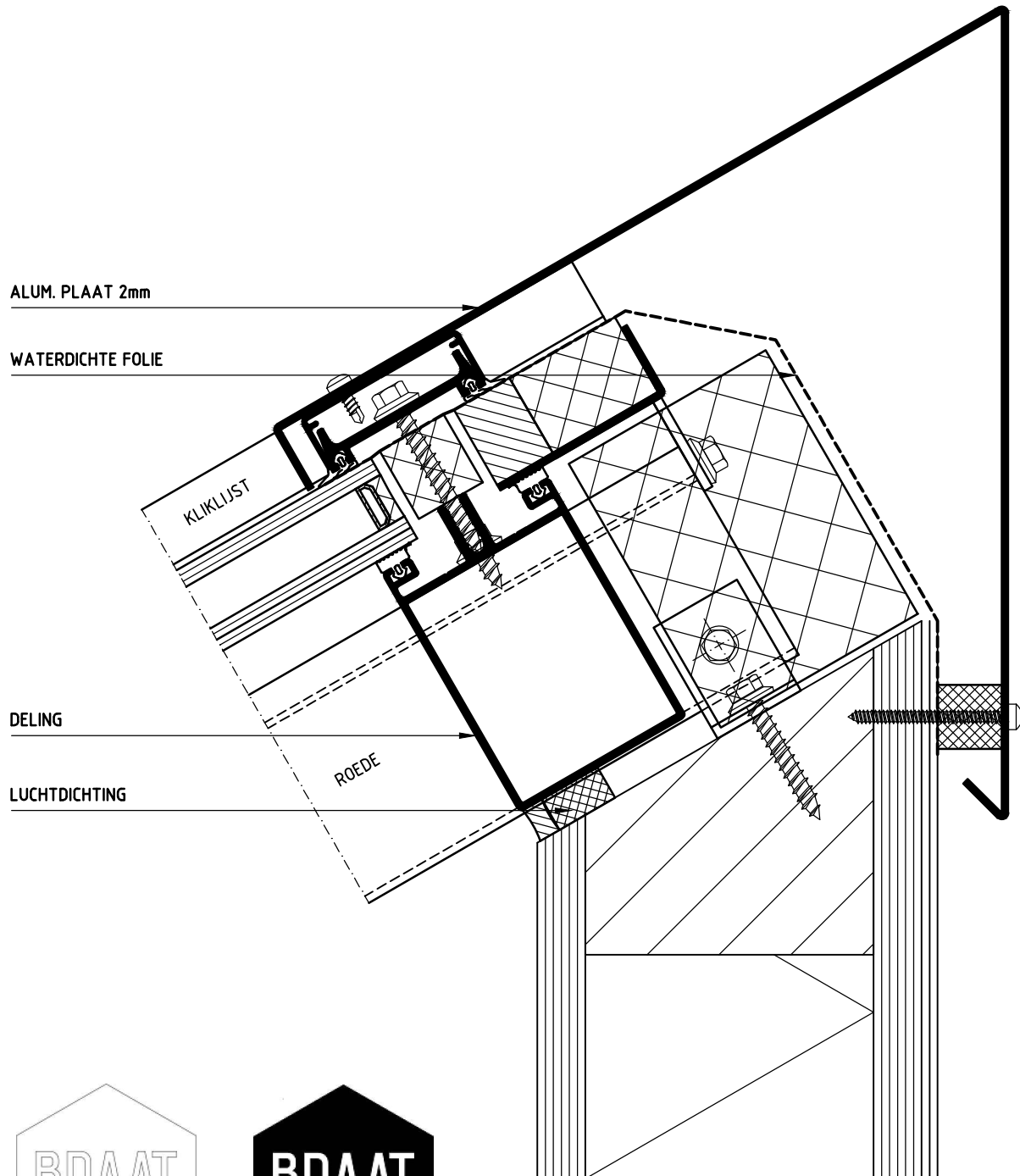

Braat glasconstructies 1844 BV
Postbus 6
2600 AA Delft
T: +31(0)15 2516767
F: +31(0)15 2571667
E: info@braatglasconstructies.nl
I: www.braatglasconstructies.nl

Braat 1844 HI (dubbel glas)

DOORSNEDE
Schaal 1:2

DETAIL 6

KLIKLIJST

WATERDICHTE FOLIE

EPDM RUBBER

DEKLIJST

PUR ISOLATIE

WATERVOERENDE SPONNING

ROEDE

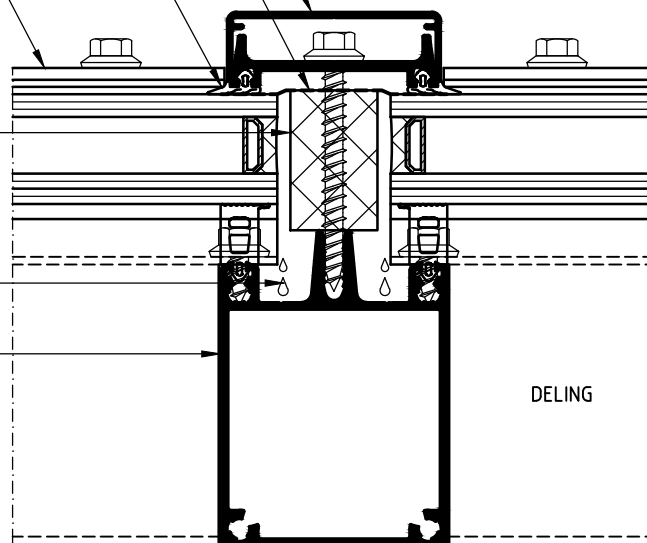

Braat glasconstructies 1844 BV
Postbus 6
2600 AA Delft
T: +31(0)15 2516767
F: +31(0)15 2571667
E: info@braatglasconstructies.nl
I: www.braatglasconstructies.nl

Braat 1844 HI (dubbel glas)

ZIJDETAIL BOUWKUNDIG KOPSCHOT
Schaal 1:2

DETAIL 7

ALUM. PLAAT 2mm

KLIKLIJST

DEKLIJST

PUR ISOLATIE

WATERDICHE FOLIE

ROEDE

LUCHTDICHTING

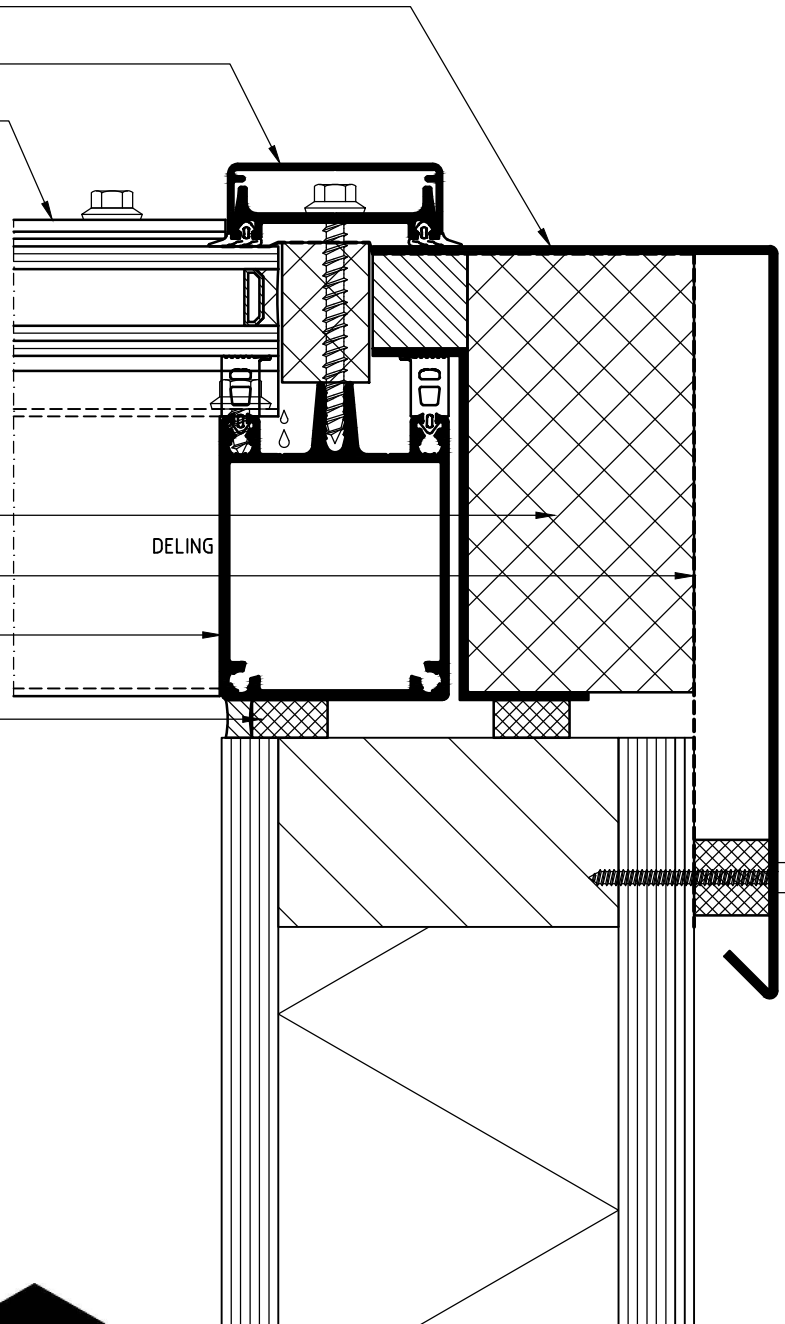

Braat glasconstructies 1844 BV
Postbus 6
2600 AA Delft
T: +31(0)15 2516767
F: +31(0)15 2571667
E: info@braatglasconstructies.nl
I: www.braatglasconstructies.nl

Braat 1844 HI (dubbel glas)

ZIJDETAIL OPGAAND WERK
Schaal 1:2

DETAIL 8

SLABBE

WATERDICHTE FOLIE

ALUM. PLAAT 2mm

KLIKLIJST

DEKLIJST

ROEDE

DELING



Braat glasconstructies 1844 BV
Postbus 6
2600 AA Delft
T: +31(0)15 2516767
F: +31(0)15 2571667
E: info@braatglasconstructies.nl
I: www.braatglasconstructies.nl

Braat 1844 HI (dubbel glas)

ZIJDETAIL GLAZEN KOPSHOT
Schaal 1:2

DETAIL 9

KLIKLIJST

WATERDICHTE FOLIE

ALUM. PLAAT 2mm

ROEDE

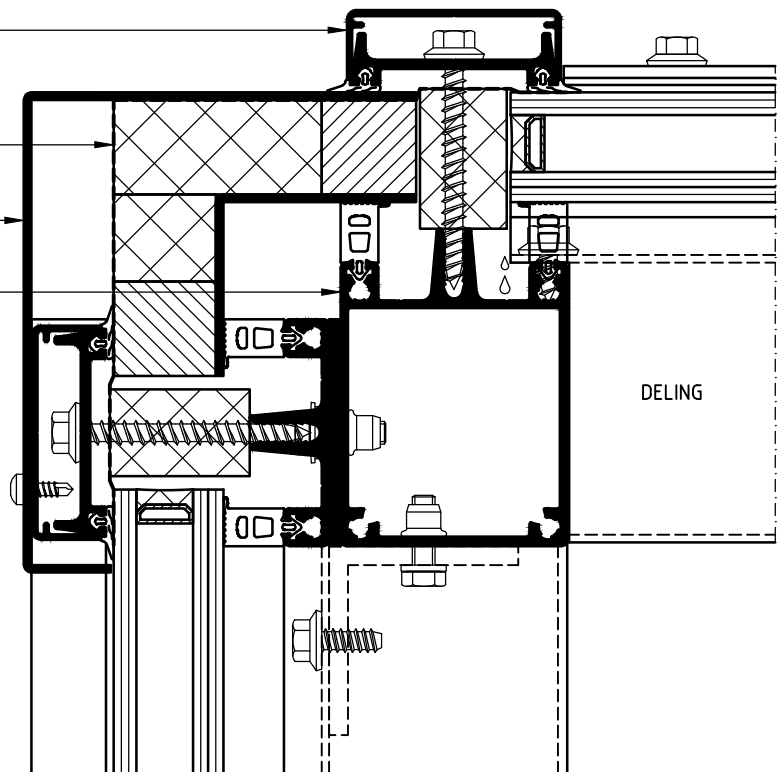

LUCHTDICHTING

SLABBE

DELING

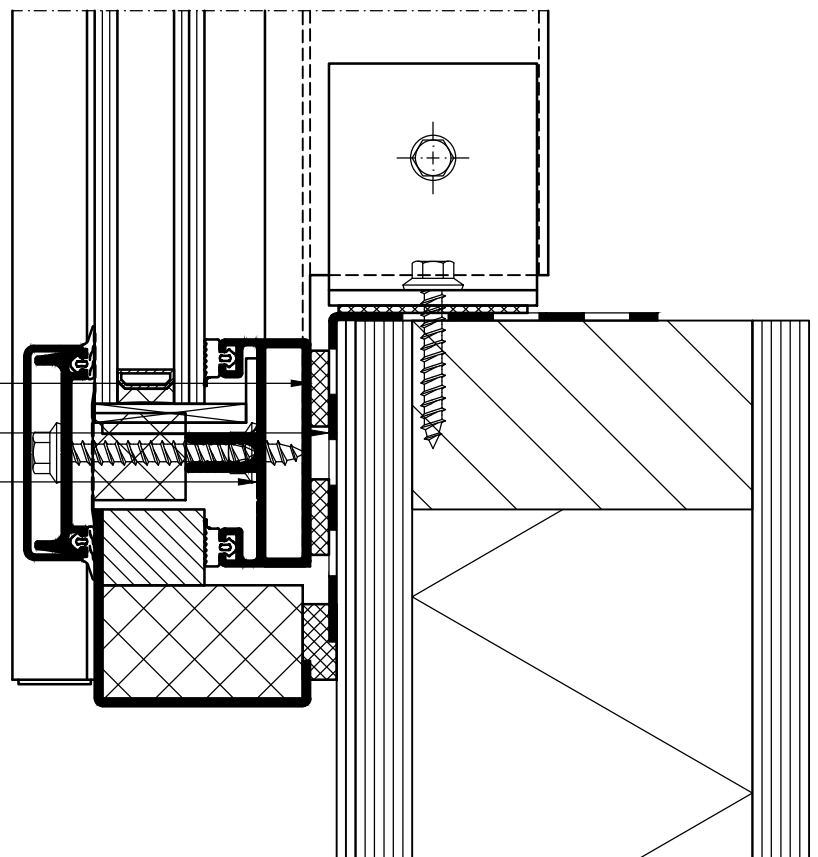

Braat glasconstructies 1844 BV
Postbus 6
2600 AA Delft
T: +31(0)15 2516767
F: +31(0)15 2571667
E: info@braatglasconstructies.nl
I: www.braatglasconstructies.nl